



شركة المقص الفني  
Technical Scissors Co.

# MicaM







INDEX THE CATALOGUE



COMBAT ARMY UNIFORM | MILITARY UNIFORMS  
FABRIC SAMPLES

16-25

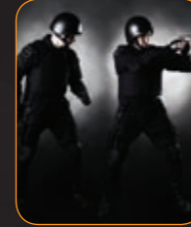

POLICE & SECURITY UNIFORMS | FIREFIGHTER UNIFORMS

26-39



CEREMONY UNIFORMS

40-45

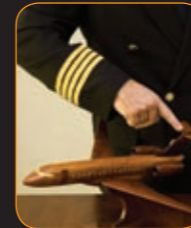

CAPTAIN UNIFORMS | CREW UNIFORMS | WORKER UNIFORMS  
OFFICE UNIFORMS | COVERALLS

46-59



RANKS & BADGES | EMBROIDERY BADGES HAND MADE  
EMBROIDERY METAL | BADGES RANKS | NISHANS & MEDALS  
MILITARY LANYARDS

60-83

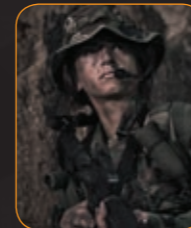

MILITARY ACCESSORIES  
CAP, HAT & BERETS | FLASH LIGHTS | BINOCULARS | GOGGLES  
MICAM BAGS | WRISTBAND | HOLSTERS | BELTS | GLOVES  
T-SHIRT | FLAGS | MILITARY WALLET | SOCKS | PROTECTION

84-141

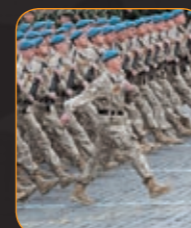

MICAM SHOES & BOOTS | ANTI RIOT SUIT | MILITARY TENT

142-157





COMBAT UNIFORME DE L'ARMÉE | UNIFORME MILITAIRE  
ÉCHANTILLONS DE TISSUS

16-25



POLICE | SÉCURITÉ ET POMPIER UNIFORME

26-39



UNIFORMES CÉREMONIE

40-45

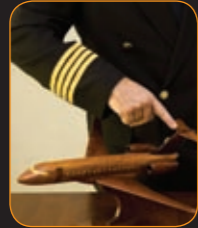

CAPITAINE UNIFORME | UNIFORME D'EQUIPAGE | UNIFORME  
TRAVAILLEUR | BUREAU UNIFORME

46-59



GRADES ET INSIGNES | BADGES BRODERIE FABRQUÉ A LA  
MAIN | MÉTAL INSIGNES | RANGS | NISHANS & MÉDAILLES  
LONGES

60-83



ACCESSOIRES MILITAIRES | Chapeau et Berét | Flash de  
Lumière | Jumelles | Lunettes Protectrice | Sacs Micam  
Bracelet | Étuis | Ceintures | Gants | T-shirt | Drapeaux  
Militaire Porte-monnaie | Chaussettes | Protection

84-141



CHAUSSURES ET BOTTES MICAM | COSTUME ANTI EMEUTE  
TENTE MILITAIRE

142-157

الزي العسكري القتالي | الزي العسكري | أنواع الأقمشة

25-16



شرطة وحماية | زي رجال الإطفاء

39-26



زي المراسم

45-40



زي الكابتن | زي الطاقم | زي العمال | زي المكاتب | كفرأول

59-46

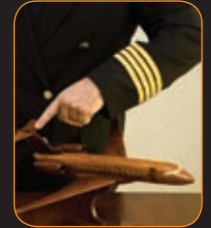

رتب وشعارات | تطوير شعارات | شعارات معدنية | شعارات رتب | ميداليات  
ونياشين | بريم

83-60



إكسسوارات عسكرية | قبعات وبرييه مصابيح يدوية  
مناظير | نظارات حماية حقائب ميكام | سوار معصم | جراب مسدس  
أحزمة | قفازات | تي شيرت | أعلام | محفظة عسكرية | جرابات | حماية

141-84



أحذية وبوت ميكام | زي مكافحة الشغب | خيم عسكرية

157-142







## INTRODUCTION

Since 1973, The Technical Scissors Company (TSC) has been a leading pioneer in the United Arab Emirates in designing, tailoring, sewing, and supplying clothes, textiles, furnishings, shoes, civil, and military equipment as per client's requirements, expectations, and as a fulfillment to all their consent.

## MISSION

We believe that there are no limits in the way we could satisfy our customers. Their needs are a point of inspiration to motivate our employees in meeting their demands. Their satisfaction is our concern.

## VISION

Our vision is to continue to be the leaders in our market by assuring total quality management in order to improve our functions and processes based on market requirements.

## OUR PHILOSOPHY OF TOTAL QUALITY LEADERSHIP

**Products and Services:** The quality of our products and services is the result of the commitment our people make to their jobs. The continuous improvement in our products and services reflects the efforts of our employees.

**People:** Our ability to compete in the market is the result of our commitment to teamwork. Employee involvement is our way of life, which empowers all employees to participate in implementing this policy and to assume responsibility for the quality of their work.

## SCOPE OF WORK AND SERVICES:

Design, Manufacture and supply of:

- Military uniforms and accessories
- Security, safety uniforms and its accessories
- Civilian uniforms and accessories
- Export and supply of personal protective equipment, textile and garments

## QUALITY POLICY

Technical Scissors Company is a pioneer in the production and supply of fabrics, and uniforms and its accessories according to the client's needs and expectations and to the complete satisfaction of all clients.

Objectives of Quality Management System:

- To achieve the planned objective and policies.
- To comply with the entire contractual requirement and the required clients specification.
- To commit to continually improving the quality of its products.
- To comply with requirements of ISO 9001:2000 International Standards.
- To comply with requirements of the statutory regulation of UAE.

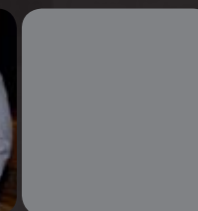





## INTRODUCTION

Depuis 1973, la compagnie technique Ciseaux (TSC) a été un pionnier dans les Émirats arabes unis dans la conception, la couture, la couture et la fourniture de vêtements, textiles, meubles, chaussures, civile, et de l'équipement militaire comme client par les exigences, les attentes, et comme un accomplissement de tous leur consentement.

## MISSION

Nous pensons qu'il n'y a pas de limites dans la façon dont nous pourrions satisfaire nos clients. Leurs besoins sont un point d'inspiration pour motiver nos employés à s'acquitter de leurs demandes. Leur satisfaction est notre préoccupation.

## VISION

Notre vision est de continuer à être les leaders sur notre marché en assurant la gestion de la qualité totale afin d'améliorer nos fonctions et des processus basés sur les exigences du marché.

## NOTRE PHILOSOPHIE DU LEADERSHIP QUALITÉ TOTALE

Produits et services: La qualité de nos produits et services est le résultat de l'engagement de notre peuple apporter à leur emploi. L'amélioration continue de nos produits et services reflète les efforts de nos employés.

People: Notre capacité à concurrencer sur le marché est le résultat de notre engagement à travailler en équipe. La participation des employés est notre mode de vie, qui autorise tous les employés à participer à la mise en œuvre de cette politique et à assumer la responsabilité pour la qualité de leur travail.

## PORTÉE DES TRAVAUX ET SERVICES:

Conception, fabrication et fourniture de:

- Les uniformes militaires L et accessoires
- L Sécurité, uniformes de sécurité et de ses accessoires
- L uniformes civils et des accessoires.
- Exporter l et la fourniture de l'équipement, du textile et des vêtements protecteurs.

## POLITIQUE DE QUALITÉ

Société Technique ciseaux est un pionnier dans la production et la fourniture de tissus, et des uniformes et ses accessoires selon les besoins du client et les attentes et à la satisfaction complète de tous les clients.

Objectifs du Système de Management Qualité:

- Pour atteindre l'objectif prévu et politiques.
- Pour se conformer à l'exigence de l'ensemble contractuel et les spécifications requises clients.
- Pour engageons à améliorer continuellement la qualité de ses produits.
- Pour se conformer aux exigences des Normes internationales ISO 9001:2000.
- Pour se conformer aux exigences de la réglementation légale des Emirats Arabes Unis.







## مقدمة

تأسست شركة المقص الفني (TSC) عام ١٩٧٣، وكانت الرائدة في دولة الإمارات العربية المتحدة في مجال تصميم وتفصيل وخياطة وتوريد الملابس والمنسوجات والأحذية بنوعيهما العسكري والمدني، وتوريد المعدات العسكرية بحسب إحتياجات العميل وتوقعاته.

## رسالتنا

نعتقد أنه لا توجد حدود في الطريقة التي يمكننا بها إرضاء عملائنا. إحتياجاتها هي نقطة للإلهام لتحفيز موظفينا في تلبية مطالبهم ورضاهم هو عملنا.

## رؤيتنا

الاستمرار في أن نكون الشركة الرائدة في مجالنا من خلال ضمان إدارة الجودة الشاملة من أجل تحسين الوظائف لدينا والعمليات القائمة على متطلبات السوق.

## فلسفة القيادة والجودة الشاملة

المنتجات والخدمات: إن نوعية منتجاتنا وخدماتنا هي نتيجة للإلتزام وحب موظفينا للعمل الذي يقومون به وذلك للتحسين المستمر في منتجاتنا وخدماتنا التي تعكس جهود موظفينا. المجتمع: إن قدرتنا على المنافسة في السوق هو نتيجة للإلتزام الجماعي. إشتراك الموظف هو طريقتنا في الحياة، والتي من خلالها يمكن جميع الموظفين على المشاركة في تنفيذ هذه السياسة وتحمل المسؤولية لتطوير نوعية عملهم.

## نطاق العمل والخدمات :

تصميم وتصنيع وتوريد :

- الزي العسكري واكسسواراته
- الأمن، زي سلامة وملحقاته
- الزي الرسمي المدني واكسسواراته
- تصدير وتوريد المعدات والمنسوجات الشخصية الواقية والملابس الجاهزة.

## سياسة الجودة

شركة المقص الفني هي شركة رائدة في مجال إنتاج وتوريد الأقمشة، والزي المدرسي وملحقاته وفقاً لإحتياجات وتوقعات جميع العملاء.

أهداف إدارة نظام الجودة:

- تحقيق الهدف المخطط والسياسات.
- تحقيق المتطلبات التعاقدية بالكامل بمواصفات العملاء المطلوبة.
- الإلتزام باستمرار تحسين نوعية منتجاتنا.
- التوافق مع متطلبات معايير الدولية ISO 9002:2000.
- التوافق مع متطلبات التنظيم القانوني لدولة الإمارات العربية المتحدة.





## The Size Measurement

### MEN'S BODY MEASUREMENTS

<b>Size:</b>	XS	S	M	L	XL	2XL	3XL	4XL	5XL
<b>Chest:</b>	30"-32"	34"-36"	38"-40"	42"-44"	46"-48"	50"-52"	54"-56"	58"-60"	62"-64"
<b>Sleeve Regular:</b>	31"-32"	32"-33"	33"-34"	34"-35"	35"-36"	36"-37"	37"-38"	38"-39"	39"-40"
<b>Long:</b>	33"-34"	34"-35"	35"-36"	36"-37"	37"-38"	38"-39"	39"-40"	40"-41"	41"-42"
<b>Short:</b>	29"-30"	30"-31"	31"-32"	32"-33"	33"-34"	34"-35"	35"-36"	36"-37"	37"-39"

**Height: Regular: 5'5"-5'9" - Short: 5'3"-5'5" - Long: 5'10"-6'3"**

24"-26"	28"-30"	32"-34"	36"-38"	40"-42"	44"-46"	48"-50"	52"-54"	56"-58"
---------	---------	---------	---------	---------	---------	---------	---------	---------

**Garment Inseam Measurements: Regular: 32" - Short: 30" - Long: 34" - Unhemmed: 37"**

### LADIES BODY MEASUREMENTS

<b>Size:</b>	XS	S	M	L	XL	2XL	3XL	4XL
<b>Bust:</b>	33"-34"	35"-36"	37"-39"	40"-42"	43"-45"	46"-49"	50"-53"	54"-57"
<b>Sleeves:</b>	30"	30-1/2"	31"	32"	32-1/2"	33"	33-1/2"	34"

**Height: Regular: 5'3"-5'7" - Petite: 5'3" & Under**

<b>Waist:</b>	2 To 27"	4 27"-28"	6 28"-29"	8 29"-30"	10 30"-31"	12 31"-32"	14 32"-33"	16 33"-34"	18 34"-35"	20 35"-36"	22 36"-37"	24 37"-38"
<b>Hips:</b>	37"	38"	39"	40"	41"	42"	44"	46"	47"	49"	50"	52"

**Garment Inseam Measurement: Unhemmed: 35"**

### FLIGHT SUIT

<b>Size:</b>	S	M	L	XL	2XL	3XL	4XL	5XL	6XL
	33"-37"	37"-40"	40"-43"	43"-46"	46"-49"	49"-52"	52"-55"	55"-58"	58"-60"

### HAT BERETS

<b>Size:</b>	XS	S	S	M	M	L	L	XL	XL
<b>Hat:</b>	6 - 3/4	6 - 7/8	7	7 - 1/8	7 - 1/4	7 - 3/8	7 - 1/2	7 - 5/8	7 - 3/4
<b>Head Size:</b>	21 - 1/8	21 - 1/2	21 - 7/8	22 - 1/4	22 - 5/8	23	23 - 1/2	24"	24 - 3/8

## How to Size the Army Combat Uniform

The Army Combat Uniform (ACU) forms a vital part of any soldier's wardrobe. These uniforms are worn in the field, combat areas, forward operating posts or anywhere they are required. As the successor to the Battle Dress Uniform (BDU) and Desert Combat Uniform (DCU), it is the primary combat uniform of the United States Army.

### Instructions

Things You will Need

- Measuring tape
- Ruler

- 1 Get a measuring tape and a ruler. Both male and female soldiers wear both pants and a jacket, and measuring for them requires the use of a measuring tape. Make sure it measures in inches. You will also need a ruler to measure for your feet.
- 2 Measure for your pants. Your trouser measurements consist of both an inseam and a waistline. The inseam is the length of the inside pant leg, from the crotch to the bottom of the ankle. Your waist measurement is taken just above your hip bones and below your belly button.
- 3 Measure for your jacket. Your jacket size also consists of two measurements: height and chest. To measure for your chest, wrap the tape measure around your chest about a two-finger length below the armpits. Your height is how tall you are. Measure this standing barefoot on a level floor, measuring from the top of your head to the ground.
- 4 Measure your feet. Place a ruler flat on the ground and stand with the back of your heel at the back of the ruler. Measure to the tip of your big toe.

### How to Design a Military Uniform

The military uniform is more than just clothing. For the soldier, sailor, pilot, or Marine, it is an outward symbol of military service, a design feature that reinforces group unity and obedience, and has practical features, such as camouflage or protection from the elements. Each branch of the armed forces has a distinct uniform with a lot of symbolic value, and even within branches, there are different kinds of uniforms for different ranks and functions. Designing a military uniform requires balancing a number of features.

### Instructions

- 1 Decide on a color for the uniform. The U.S. Army typically issues drab green and brown camouflage for its soldiers, colors that allow the soldier to blend into forested surroundings. Troops serving in the desert are issued lighter-colored camouflage that reflects those conditions. A color should balance both aesthetics and camouflage needs.
- 2 Decide whether the uniform will be for the battlefield or for ceremonial purposes. Military uniforms differ widely in this regard. Standard camouflage fatigues are heavy, practical and facilitate disguise, qualities necessary for the rigors of combat. But many military uniforms serve only ceremonial functions. These value more aesthetics than pragmatic features.
- 3 Design insignia. Military uniforms are noted for their colorful, symbolic insignia: The pins, buttons and medals signify rank, branch, battalion, commendations and honors. Insignia is important because it distinguishes members of service who have been awarded certain honors and represents differences in rank within a branch. Decide the style and color of insignia you want to use and where it will be placed on the uniform.
- 4 Choose a fabric. Cotton is lightweight and breathes more easily, making it more suitable for summertime. Khaki or winter olive drab is heavier but provides better insulation, and it may be more suitable for military service in the summer. Wool provides protection from the cold but is heavy and retains moisture.
- 5 Design proper footwear. The standard combat boots worn by the Marines and other branches, for example, are heavy-duty, durable and well-suited to combat rigors and physical labor, but the footwear you design depends on function (ceremonial or duty-related).



EXCELLENCE OF QUALITY



# COMBAT

Army Uniform | Military Uniform  
Fabric Samples

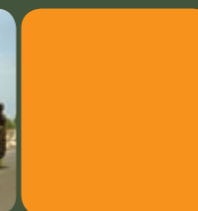



EXCELLENCE OF QUALITY



# Combat

## Army Uniform

**MILITARY RIP - STOP CAMO**  
MILITARY COLOR RIP-STOP CAMO BATTLEDRESS



**(CAU1001)**  
MILITARY RIP - STOP CAMO



**(CAU1002)**



**(CAU1003)**

Note: We Care Do New Fabric Desig And We Can Stitsh Bdu. According Coustomer Special



# Combat Army Uniform

# Combat Army Uniform

(CAU 1003)



MILITARY RIP - STOP CAMO  
RIP-STOP CAMO BATTLEDRESS



Desert Digital  
Camoplays Bdu Ripstep  
(CAU 1006)



Woodland Camouflage BDU. Ripstop  
(CAU 1004)



Green Camouflage BDU. Ripstep  
(CAU 1005)



3 Color Camo Flag Bdu. Rip Ripstep  
(CAU 1007)





# Combat Army Uniform

## MILITARY PLAIN

USA D. Gray Digital BDU. Plain  
(CAU 1008)



(CAU 1009)



USA L. Gray Digital BDU. Ripstop  
(CAU 1010)

# Combat Army Uniform

## MILITARY BDU (CAU 1011)



(CAU 1012)



(CAU 1013)



(CAU 1014)



USA Gray Digital  
(CAU 1015)



# Combat BDU Sample



# Camouflage Fabric



(CFS 1001)

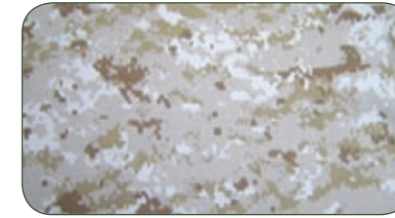

(CFS 1002)



(CFS 1003)

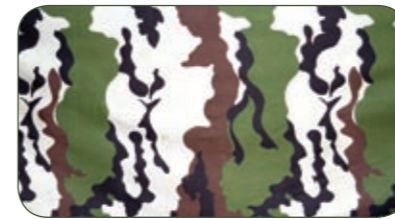

(CFS 1004)

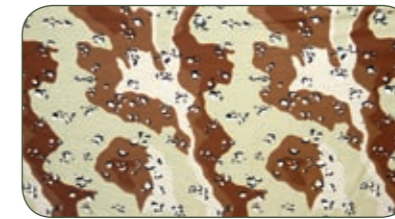

(CFS 1005)

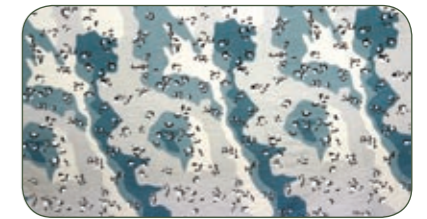

(CFS 1006)



(CFS 1007)



(CFS 1008)

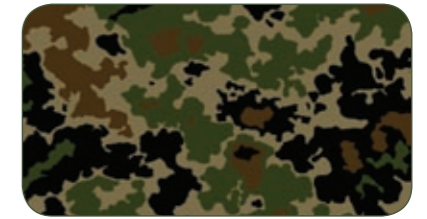

(CFS 1009)



(CFS 1010)



(CFS 1011)



(CFS 1012)

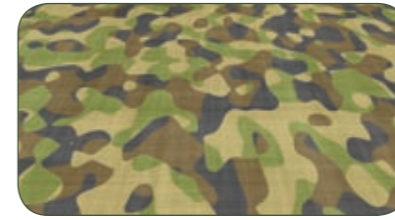

(CFS 1013)

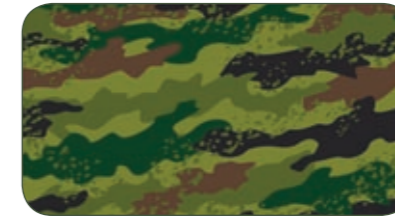

(CFS 1014)



(CFS 1015)



(CFS 1016)

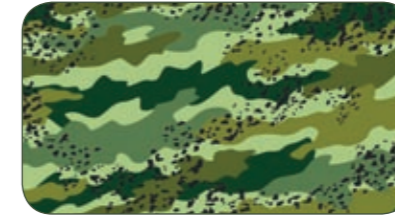

(CFS 1017)



(CFS 1018)



(CFS 1019)



(CFS 1020)



(CFS 1021)



EXCELLENCE OF QUALITY



**POLICE**  
Security &  
**Firefighter**  
Uniforms

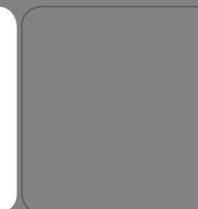



# Police & Security Uniforms

EXCELLENCE OF QUALITY



Black Ripstop  
(PSU-1001)



(Embroidary)  
(PSU-1002)

POLIC BATTLEDRESS  
TENUE F2 FAG RIP-STOP CAMO  
F2 FAG RIP-STOP CAMO BATTLEDRESS



Light Green  
(PSU-1003)





## POLICE UNIFORM



(PSU-1004)



(PSU-1005)

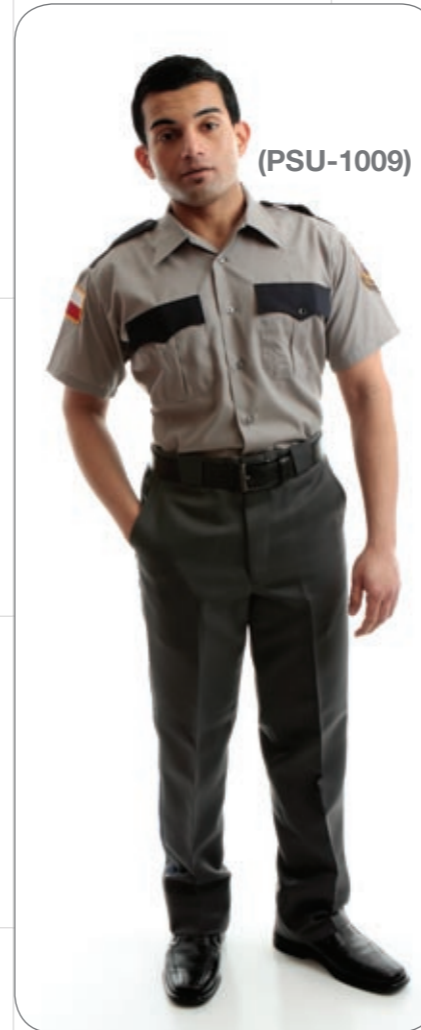

(PSU-1009)



POLICE UNIFORM  
(PSU-1010)



(PSU-1006)  
Black



(PSU-1007)  
Sty Blue

TENUE F2 FAG RIP-STOP CAMO  
F2 FAG RIP-STOP CAMO BATTLEDRESS



(PSU-1008)  
Navy

TENUE F2 FAG RIP-STOP CAMO  
F2 FAG RIP-STOP CAMO BATTLEDRESS



(PSU-1011)  
Kholu





POLICE BAITEL DRESS

POLICE BAITEL DRESS



(PSU-1013)



(PSU-1014)



(PSU-1015)



(PSU-1016)



(PSU-1017)



(PSU-1018)



EXCELLENCE OF QUALITY



(PSU-1019)



(PSU-1020)



(PSU-1021)



POLICE UNIFORM



(PSU-1022)



(PSU-1023)

POLICE UNIFORM

Wollen Jevsy / Polover  
(PSU-1026)



Nay Coat  
(PSU-1027)



(PSU-1024)



(PSU-1025)



Rain Jackt  
(PSU-1028)





EXCELLENCE OF QUALITY



# Police & Security Uniforms



(PFU-1001)

Police Vestpj 2012  
(PFU-1002)



(PFU-1005)

Pivrsuit  
(PFU-1006)



(PFU-1004)





EXCELLENCE OF QUALITY



# CEREMONIAL Uniforms





# Ceremonial Uniforms



(SU-1001)

(SU-1002)



(SU-1003)



(SU-1004)



(SU-1005)



(SU-1006)







EXCELLENCE OF QUALITY



# CAPTAIN Uniforms

Crew Uniforms | Worker Uniforms  
Office Uniforms | Coveralls Uniforms





EXCELLENCE OF QUALITY



# Captain Uniforms



(CU-1000)

WOMEN CAPTAIN UNI  
PORN (WS-1002)



(CU-1001)

PILOT COVERALL



(CU-1003)



(CU-1004)



EXCELLENCE OF QUALITY

# Crew Uniforms





# Worker Uniforms



(WU-1000)



(WU-1001)



(WU-1002)



(WU-1003)



(WU-1004)



(WU-1005)



(WU-1006)



(WU-1007)



(WU-1008)



(WU-1009)



(WU-1010)

(WU-1011)





# Worker Uniforms

# Worker Uniforms



(WU-1012)



(WU-1013)



(WU-1014)



(WU-1019)



(WU-1020)



(WU-1021)



(WU-1022)



(WU-1023)



(WU-1024)



(WU-1015)



(WU-1016)



(WU-1017)



(WU-1018)



(WU-1025)



(WU-1026)



(WU-1027)





(OU-1000)



(OU-1001)



(OU-1004)



(OU-1005)



(OU-1002)



(OU-1003)



(OU-1006)



(OU-1007)





(COU-1000)



(COU-1001)



(COU-1004)



(COU-1005)



(COU-1002)



(COU-1003)



(COU-1006)



(COU-1007)



EXCELLENCE OF QUALITY



## RANKS & Badge

Embroidery Badges | Hand Made  
Embroidery Metal | **Badges Ranks** Nishans  
Medals & Lanyards

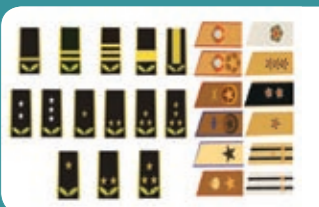
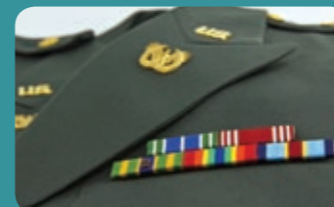



# Ranks & Badges

## Embroidery Badges



(EB-1000)



(EB-1002)



(EB-1003)



(EB-1004)



(EB-1005)



(EB-1006)



(EB-1007)



(EB-1008)



(EB-1009)



(EB-1010)



(EB-1011)



(EB-1012)



# Ranks & Badges

## Embroidery Badges

# Ranks & Badges

## Plastic Badges



(EB-1013)



(EB-1014)



(EB-1015)



(EB-1025)



(EB-1026)



(EB-1027)



(EB-1016)



(EB-1017)



(EB-1018)



(EB-1028)



(EB-1029)



(EB-1030)



(EB-1019)



(EB-1020)



(EB-1021)



(EB-1031)



(EB-1032)



(EB-1033)



(EB-1022)



(EB-1023)



(EB-1024)



(EB-1034)



(EB-1035)



(EB-1036)



# Ranks & Badges

Embroidery or Plastic Badges



(EB-1037)



(EB-1038)



(EB-1039)



(EB-1040)



(EB-1041)



(EB-1042)



(EB-1043)



(EB-1044)



(EB-1045)



(EB-1046)



(EB-1047)



(EB-1048)

# Ranks & Badges

Embroidery Badges



(EB-1049)



(EB-1050)



(EB-1051)



(EB-1052)



(EB-1053)



(EB-1054)



(EB-1055)



(EB-1056)



(EB-1057)



(EB-1058)



(EB-1059)



(EB-1060)



(EB-1061)



(EB-1062)



(EB-1063)



(EB-1064)



(EB-1065)



(EB-1066)





EXCELLENCE OF QUALITY

# Ranks & Badges

Hand Made Badges



(HE-1000)



(HE-1001)



(HE-1002)



(HE-1003)



(HE-1004)



(HE-1005)



(HE-1006)



(HE-1007)



(HE-1008)



(HE-1009)



(HE-1010)



(HE-1011)



(HE-1012)



(HE-1011)



(HE-1012)



(HE-1013)



(HE-1014)



# Ranks & Badges

## Metal Badges

# Ranks & Badges

## Metal Badges

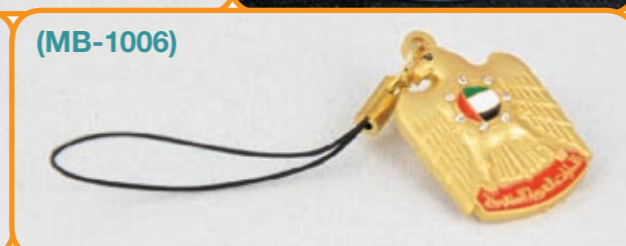





# Ranks & Badges

## Buttons



(B-1000)



(B-1001)



(B-1002)



(B-1003)



(B-1004)



(B-1005)



(B-1006)



(B-1007)



(B-1008)



(B-1009)



(B-1010)



(B-1011)



(B-1012)



(B-1013)



(B-1014)





# Ranks & Badges

## Ranks



(R-1000)



(R-1001)

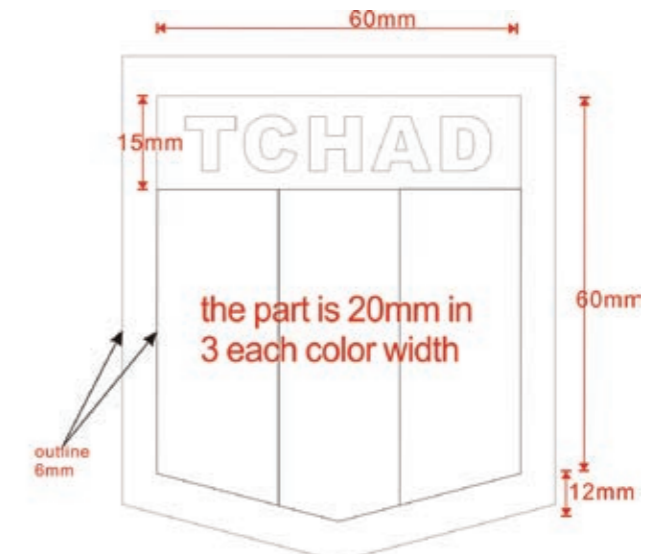

back side with vecro

(R-1002)

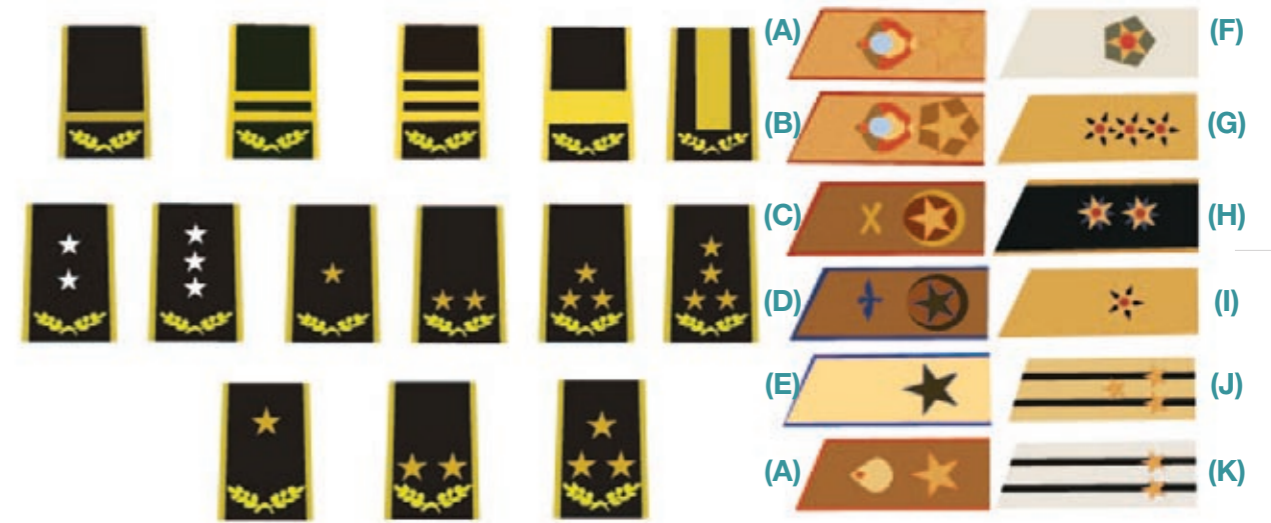

(R-1003)

(R-1004)



# Ranks & Badges

## Ranks

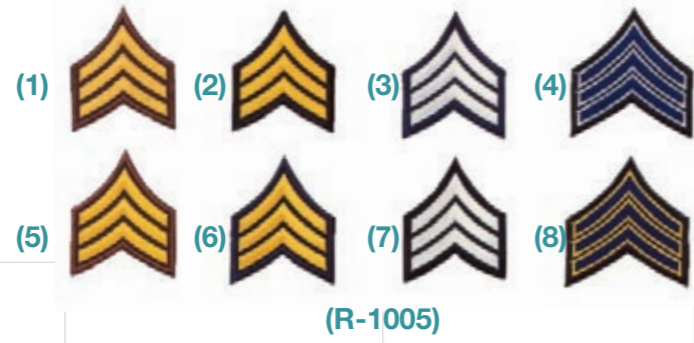

(R-1005)

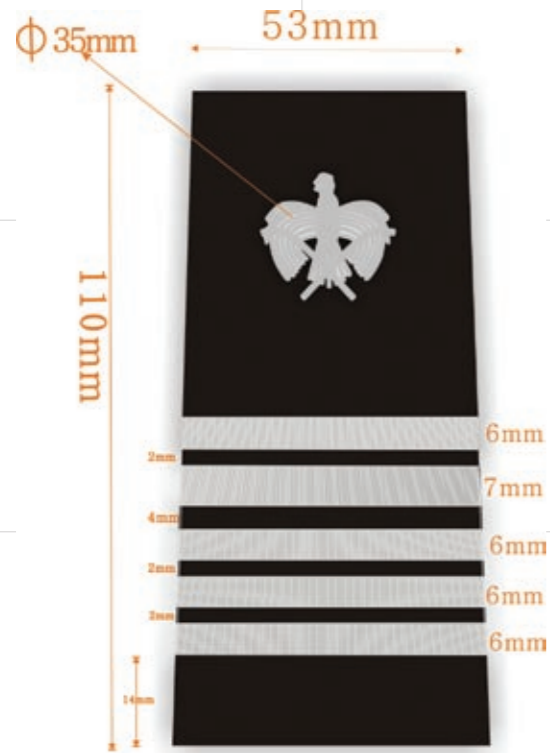

(R-1006)

60mm



(R-1007)

60mm

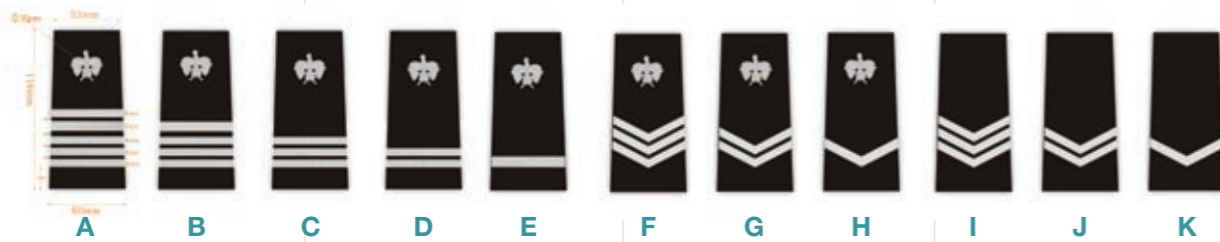

(R-1008)



(R-1009)

# Ranks & Badges

## Ranks

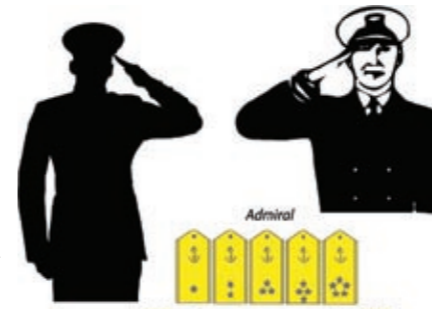

(R-1010)

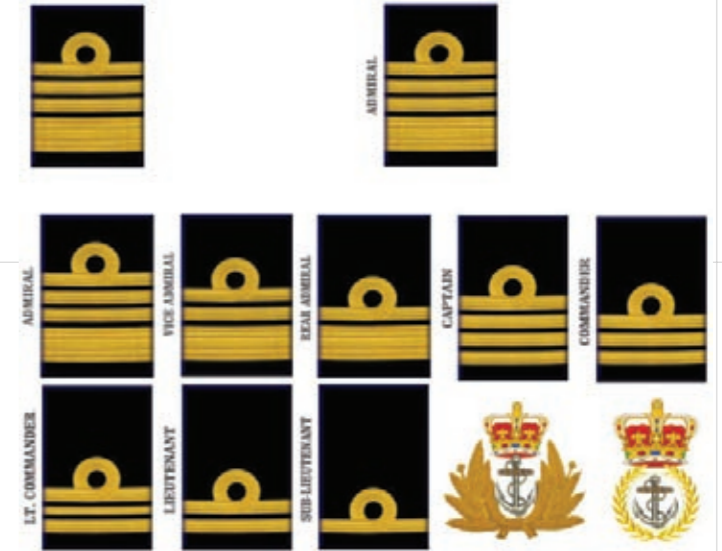

(R-1011)



(R-1012)



(R-1013)



(R-1012)



(R-1013)



(R-1014)



(R-1015)



# Ranks & Badges

## Ranks

# Ranks & Badges

## Embroidery Ranks

### Insignia of the United States Armed Forces – Officers

O-1	O-2	O-3	O-4	O-5	O-6	O-7	O-8	O-9	O-10	SPECIAL
<b>ARMY</b>										
Second Lieutenant (2LT)	First Lieutenant (1LT)	Captain (CPT)	Major (MAJ)	Lieutenant Colonel (LTC)	Colonel (COL)	Brigadier General (BG)	Major General (MG)	Lieutenant General (LTG)	General (GEN)	General of the Army (GA)
A	B	C	D	E	F	H	I	J	K	L
(R-1016)										
<b>MARINES</b>										
Second Lieutenant (2ndLt)	First Lieutenant (1stLt)	Captain (Capt)	Major (Maj)	Lieutenant Colonel (LtCol)	Colonel (Col)	Brigadier General (BGen)	Major General (MajGen)	Lieutenant General (LtGen)	General (Gen)	
A	B	C	D	E	F	H	I	J	K	L
(R-1017)										
<b>NAVY</b>										
Ensign (ENS)	Lieutenant Junior Grade (LTJG)	Lieutenant (LT)	Lieutenant Commander (LCDR)	Commander (CDR)	Captain (CAPT)	Rear Admiral Lower Half (RADML)	Rear Admiral Upper Half (RADM)	Vice Admiral (VADM)	Admiral (ADM)	Fleet Admiral (FADM)
A	B	C	D	E	F	H	I	J	K	L
(R-1018)										
<b>AIR FORCE</b>										
Second Lieutenant (2d Lt)	First Lieutenant (1st Lt)	Captain (Capt)	Major (Maj)	Lieutenant Colonel (Lt Col)	Colonel (Col)	Brigadier General (Brig Gen)	Major General (Maj Gen)	Lieutenant General (Lt Gen)	General (Gen)	
A	B	C	D	E	F	H	I	J	K	L
(R-1019)										
<b>COAST GUARD</b>										
Ensign (ENS)	Lieutenant Junior Grade (LTJG)	Lieutenant (LT)	Lieutenant Commander (LCDR)	Commander (CDR)	Captain (CAPT)	Rear Admiral Lower Half (RADML)	Rear Admiral Upper Half (RADM)	Vice Admiral (VADM)	Admiral (ADM)	
A	B	C	D	E	F	H	I	J	K	L
(R-1020)										

(R-1021)	(R-1022)	(R-1023)
(R-1024)	(R-1025)	(R-1026)
(R-1027)	(R-1028)	(R-1029)
(R-1030)	(R-1031)	(R-1032)
(R-1033)	(R-1034)	(R-1035)
(R-1036)	(R-1037)	(R-1038)
(R-1039)	(R-1040)	(R-1041)
(R-1042)	(R-1043)	(R-1044)



# Ranks & Badges

## Military Medals



(LCS-1000)



(LCS-1001)



(LCS-1002)



(LCS-1003)



(LCS-1004)



(LCS-1005)



(LCS-1006)



(LCS-1007)



(LCS-1008)



(LCS-1009)



(LCS-1010)



(LCS-1011)



(LCS-1012)



(LCS-1013)



(LCS-1014)



(LCS-1015)



(LCS-1016)



(LCS-1017)



(LCS-1018)



(LCS-1019)



(LCS-1020)



(LCS-1021)



(LCS-1022)



EXCELLENCE OF QUALITY



## Ranks & Badges

### Military Lanyards



(LCS-1023)



(LCS-1024)



(LCS-1025)



(LCS-1026)



(LCS-1028)



(LCS-1029)



(LCS-1030)



(LCS-1031)



EXCELLENCE OF QUALITY



## MILITARY Accessories

Cap, Hat & Berets | Flash Lights |  
Binoculars | Goggles | Micam Bags |  
Wristband | Holsters | Belts | Gloves |  
T-Shirt | Flags | Military Wallet |  
Socks | Protection





EXCELLENCE OF QUALITY



# Military Accessories

## Cap & Hat



(CHB-1000)



(CHB-1001)



(CHB-1002)



(CHB-1003)



(CHB-1004)



(CHB-1005)



(CHB-1006)



(CHB-1007)



(CHB-1008)



(CHB-1009)



(CHB-1010)



(CHB-1011)



(CHB-1012)





# Military Accessories

## Cap



(CHB-1013)



(CHB-1014)



(CHB-1015)



(CHB-1016)



(CHB-1017)



(CHB-1018)



(CHB-1019)



(CHB-1020)



(CHB-1021)



(CHB-1022)



(CHB-1023)



(CHB-1024)



(CHB-1025)

# Military Accessories

## Cap & Hat



(CHB-1026)



(CHB-1027)



(CHB-1028)



(CHB-1029)



(CHB-1030)



(CHB-1031)



(CHB-1032)



(CHB-1033)



(CHB-1034)



# Military Accessories

## Berets



(CHB-1035)



(CHB-1036)



(CHB-1037)



(CHB-1038)



(CHB-1039)



(CHB-1040)



(CHB-1041)



(CHB-1042)



(CHB-1043)



(CHB-1044)

# Military Accessories

## Helmet



(H-1001)



(H-1002)



(H-1003)



(H-1004)



(H-1005)



EXCELLENCE OF QUALITY



# Military Accessories

## Flashlights



(F-1000)  
LENTH SIZ 22 CM  
R-SHARJABLE



(F-1001)  
LENTH SIZ 22 CM  
3 LED LIGHT  
RECHARGEABLE



(F-1002)  
LENTH SIZ 13.5 CM



(F-1003)  
LENTH SIZ 13.5 CM



(F-1004)  
LENTH SIZ 16 CM  
LED LIGHT RECHARGEABLE



(F-1005)  
LENTH SIZ 20 CM  
LED LIGHT RECHARGEABLE



(F-1006)  
LENTH SIZ 16 CM  
LED LIGHT RECHARGEABLE



(F-1007)  
LENTH SIZ 13.5 CM  
LED LIGHT RECHARGEABLE



(F-1008)  
LENTH SIZ 16 CM  
LED LIGHT RECHARGEABLE



(F-1009)  
LENTH SIZ 7.5 CM  
LIGHT COLOR  
RED - WHITE - GREEN



EXCELLENCE OF QUALITY



## Military Accessories

### Binoculars

(B-1001)



(B-1000)



(B-1002)



(B-1003)



(B-1004)



(B-1005)



EXCELLENCE OF QUALITY



## Military Accessories

### Micam Eyewear



(G-1000)



(G-1001)



(G-1002)



(G-1003)



(G-1005)



(G-1006)



(G-1004)



EXCELLENCE OF QUALITY



# Military Accessories

## MicaM Bags



(MB-1000)



(MB-1001)



(MB-1002)





# Military Accessories

## MicaM Hydration Bags

# Military Accessories

## MicaM Bags



(MB-1004)

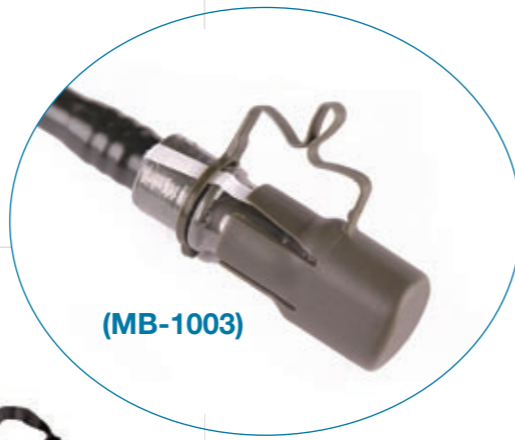

(MB-1003)



(MB-109)



(MB-1007)



(MB-1005)



(MB-1006)



(MB-1008)



(MB-1010)



(MB-1011)





# Military Accessories

## MicaM Bags



(MB-1012)



(MB-1013)



(MB-1018)



(MB-1014)



(MB-1015)



(MB-1019)



(MB-1020)



(MB-1016)



(MB-1017)



(MB-1021)



(MB-1022)

# Military Accessories

## MicaM Bags & Accessories



# Military Accessories

## MicaM Army Bags With Accessories (Kampsack)

# Military Accessories

## MicaM Army Bags (Kampsack)



(MB-1023)



(MB-1024)





# Military Accessories

## MicaM Bags



(MB-1025)



(MB-1026)



(MB-1027)



(MB-1028)



(MB-1029)

# Military Accessories

## MicaM Bags



(MB-1030)



(MB-1031)



(MB-1032)



(MB-1033)



(MB-1034)



# Military Accessories

## Magnetic Bracelet



(W-1000)



(W-1001)



(W-1002)



(W-1003)



(W-1004)



(W-1005)



(W-1006)



(W-1007)



(W-1008)





EXCELLENCE OF QUALITY



## Military Accessories

### Holsters



(W-1000)



(W-1001)

(W-1002)



(W-1003)



(W-1004)



(W-1005)



# Military Accessories

## Belt Holsters



(W-1006)



(W-1007)



(W-1008)



(W-1009)



(W-1010)



(W-1011)



(W-1012)



(W-1013)



(W-1014)

# Military Accessories

## Holsters



(W-1015)



(W-1016)



(W-1017)



(W-1018)



(W-1019)



(W-1020)



Hand Cuff Cover  
(W-1021)



(W-1022)



(W-1023)



EXCELLENCE OF QUALITY

## Military Accessories

### Brass Platter Military web Belt





# Military Accessories

## Bdu Belts



(B-1008)



(B-1009)



(B-1010)



(B-1011)



(B-10012)

# Military Accessories

## Military Belt

Leather Belt



(B-1013)



Leather Belt

(B-1014)



(B-1015)



(B-1016)



(B-1017)



(B-1018)



(B-1019)



(B-1020)



(B-1021)



(B-1022)



(B-1023)



(B-1024)



(B-1025)



(B-1026)



EXCELLENCE OF QUALITY

# Military Accessories

## Tactical Gloves



(G-1000)



(G-1001)



(G-1002)



(G-1003)



(G-1004)



(G-1005)



(G-1006)



(G-1007)



EXCELLENCE OF QUALITY



# Military Accessories

## Camouflage T-Shirt



(TS-1000)



(TS-1001)



(TS-1002)



(TS-1003)



(TS-1004)



(TS-1005)



(TS-1006)



(TS-1007)



(TS-1008)



(TS-1009)



(TS-1010)



(TS-1011)



# Military Accessories

## Military T-Shirt



(TS-1012)



(TS-1013)



(TS-1014)



(TS-1015)



(TS-1016)



(TS-1017)



(TS-1018)



(TS-1019)



(TS-1020)



(TS-1021)



(TS-1022)



(TS-1023)

# Military Accessories

## Polo T-Shirt



(TS-1024)



(TS-1025)



(TS-1026)



(TS-1027)



(TS-1028)



(TS-1029)



(TS-1030)



# Military Accessories

## Polo T-Shirt

(TS-1031)



(TS-1032)



(TS-1033)

(TS-1034)



(TS-1035)

(TS-1036)

# Military Accessories

## Shirts



(TS-1037)



(TS-1038)



(TS-1039)



(TS-1040)



(TS-1041)



(TS-1042)



(TS-1043)





# Military Accessories

## Tactical Pants, Vest and Shirts

MICAM SHIRTS (TS-1044)



TACTICAL VEST (TS-1045)

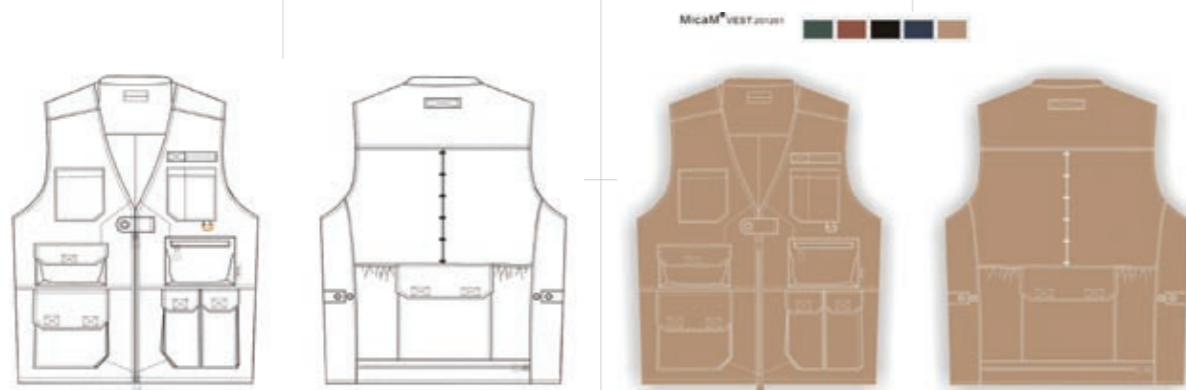

MICAM TACTICAL PANTS (TS-1046)



# Military Accessories

## Shirt & Jackets

WORKING SHIRTS

(TS-1047)



(TS-1048)



(TS-1049)



(TS-1050)



(TS-1051)



(TS-1052)



MILITARY JACKET (TS-1053)



LONG COAT

(TS-1054)



(TS-1055)







# Military Accessories

## Flags



(F-1000)



(F-1001)



(F-1002)



(F-1003)



(F-1004)



EXCELLENCE OF QUALITY

# Military Accessories

## Military Wallet



(MW-1000)

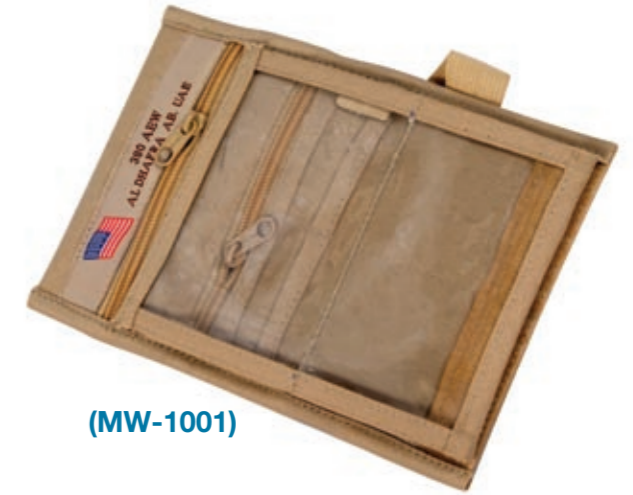

(MW-1001)



(MW-1002)



(MW-1003)



(MW-1004)



(MW-1005)





(51-07-MIXI)

# Military Accessories

## Military Socks



(S-1000)



(S-1001)



(S-1002)



(S-1003)



(S-1004)



(S-1005)



(S-1006)



(S-1007)



(S-1008)



(S-1009)



(S-1010)



(S-1012)



# Military Accessories

## Military Socks

# Military Accessories

## Military Socks



(S-1013)



(S-1014)



(S-1015)



(S-1016)



(S-1023)



(S-1024)



(S-1017)



(S-1018)



(S-1019)



(S-1025)



(S-1026)



(S-1020)



(S-1021)



(S-1022)



(S-1027)



(S-1028)



EXCELLENCE OF QUALITY



**PROTECTION**





EXCELLENCE OF QUALITY

# Protection

## Vest



(P-1000)



(P-1001)



(P-1002)



(P-1003)



(P-1004)



(P-1005)



## Protection Bullet Proof Vest

## Protection Reflective Vest



(P-1008)



(P-1012)



(P-1013)



(P-1006)



(P-1007)



(P-1014)



(P-1015)



(P-1009)



(P-1010)



(P-1011)



(P-1016)



(P-1017)



EXCELLENCE OF QUALITY



# MICAM

## Shoes & Boots

Anti Riot Suit | Military Tent

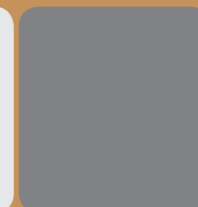



EXCELLENCE OF QUALITY



# Micam Shoes & Boots

## Tactical Boots



(MSB-1001)



(MSB-1000)



(MSB-1002)



(MSB-1003)



(MSB-1004)



(MSB-1005)



(MSB-1006)



# Micam Shoes & Boots

## Tactical Boots

# Micam Shoes & Boots

## Tactical Boots



(MSB-1007)



(MSB-1008)



(MSB-1018)



(MSB-1019)



(MSB-1009)



(MSB-1010)



(MSB-1011)



(MSB-1020)



(MSB-1021)



(MSB-1021)



(MSB-1012)



(MSB-1013)



(MSB-1014)



(MSB-1022)



(MSB-1023)



(MSB-1024)



(MSB-1015)



(MSB-1016)



(MSB-1017)



(MSB-1025)



(MSB-1026)



(MSB-1027)



# Micam Shoes & Boots

## Tactical Boots



(MSB-1028)



(MSB-1029)

# Micam Shoes & Boots

## Tactical Boots



(MSB-1040)



(MSB-1041)



(MSB-1030)



(MSB-1031)



(MSB-1032)



(MSB-1042)



(MSB-1043)



(MSB-1044)



(MSB-1033)



(MSB-1034)



(MSB-1035)



(MSB-1045)



(MSB-1046)



(MSB-1047)



(MSB-1036)



(MSB-1037)



(MSB-1039)



(MSB-1048)



(MSB-1049)



(MSB-1050)



# Micam Shoes & Boots

## Military Boots



(MSB-1051)



(MSB-1052)



(MSB-1053)



(MSB-1054)



(MSB-1055)



(MSB-1056)



(MSB-1057)



(MSB-1058)



(MSB-1059)



(MSB-1060)



(MSB-1061)

# Micam Shoes & Boots

## Officers Boots



(MSB-1062)



(MSB-1063)



(MSB-1064)



(MSB-1065)



(MSB-1066)



(MSB-1067)



(MSB-1068)



(MSB-1069)



(MSB-1070)



(MSB-1071)



(MSB-1072)



# Military Tent

(MT-1000)



(MT-1001)



# Military Stretcher

(MT-1002)



(MT-1003)



(MT-1005)



(MT-1004)



(MT-1006)



(MT-1007)





# Anti Riot Suit

# Anti Riot Suit





# Anti Riot Suit

# Anti Riot Suit





LAST NAME: .....

FIRST NAME: .....

ARMY CORPS: .....

RANK: .....



شركة المقص الفني  
Technical Scissors Co.

HEAD SIZE

SHOE SIZE

NECK SIZE

1



HAUTEUR SOUS TOISE  
HEIGHT

2



POIDS  
WEIGHT

3

LONGUEUR  
DE VESTE  
JACKET LENGHT



6

LONGUEUR  
DE MANCHE  
SLEEVE LENGTH

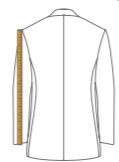

9

TOUR DE BASSIN  
HIP



4

LONGUEUR  
DE MANTEAU  
COAT LENGTH

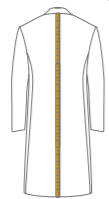

7

TOUR DE  
POITRIN  
CHEST



10

LONGUEUR DE COTE'  
SIDE LENGHT



5

DEMI-CARRURE  
HALF-SHOULDER



8

TOUR DE  
CEINTURE  
WAIST



11

LONGUEUR  
D'ENTREJAMBE  
INSEAM

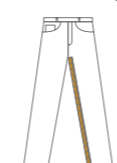



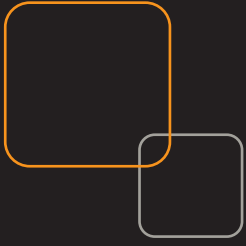

## Technical Scissors Co.

### Abu Dhabi

#### Main Branch

Tel. : +971 2 6662115  
Fax : +971 2 6668436  
P.O.Box: 2311

### Abu Dhabi

#### Al Muroor Branch

Tel. : +971 2 4454764  
Fax : +971 2 4454765  
P.O.Box: 2311

### Dubai

Tel. : +971 4 3598359  
Fax : +971 4 3552283  
P.O.Box: 115531

### Al Ain Branch (1)

Tel. : +971 3 7669804  
Fax : +971 3 7512051  
P.O.Box: 15260

### Al Ain Branch (2)

Tel. : +971 3 7619565  
Fax : +971 3 7619564  
P.O.Box: 15260

### Al Sharjah

Tel. : +971 6 5539935  
Fax : +971 6 5538851  
P.O.Box: 19797

### Ras Al Khaima (1)

Tel. : +971 7 2355331  
Fax : +971 7 2355881  
P.O.Box: 3447

### Ras Al Khaima (2)

Tel. : +971 7 2339304  
Fax : +971 7 2339305  
P.O.Box: 2297

### Al Fujairah

Tel. : +971 9 2222107  
Fax : +971 9 2222083  
P.O.Box: 2959

### Ajman

Tel. : +971 6 7499789  
Fax : +971 6 7497735  
P.O.Box: 15047

### Qatar

Tel. : +974 44442214  
Fax : +974 44442215  
P.O.Box: 37732